



CLARK COUNTY PUBLIC ART COMMITTEE

Sunset Parks & Recreation Admin Building

2601 E. Sunset Rd., Las Vegas, NV 89120

March 12, 2024

3:30 PM

MINUTES

Board/Council Members: Alfredo Fernández-González, Chairperson
Jerry Schefcik, Vice-Chairperson
Alexia Chen
Heather Harmon
Jeff Fulmer- **Absent**
Kenneth Ruffin
Mary Sabo

Secretary: Tammy To, 702-455-8685, CCpublicArt@ClarkCountyNV.gov
Business Address: Sunset Administration Building, 2601 E. Sunset Rd, Las Vegas, Nevada 89120

County Liaison(s): Mickey Sprott, 702-455-8685, Mickey1@ClarkCountyNV.Gov
Business Address: Sunset Administration Building, 2601 E. Sunset Rd, Las Vegas, Nevada 89120

1. Call to Order, Roll call.
Meeting called to order at 3:37 PM by Chairperson Alfredo Fernandez-Gonzalez.
2. Public Comment.
No public comment.
3. Approval of the Agenda for March 12, 2024 (*for possible action*).
MOTION by Jerry Schefcik
2nd MOTION by Alexia Chen
Action PASSED / Unanimous (4-0)
4. Approval of Minutes for February 13, 2024 (*for possible action*).
MOTION by Mary Sabo
2nd MOTION by Jerry Schefcik
Action PASSED / Unanimous (4-0)
5. Budget Presentations (*not an action item*).
 - a. Southwest Ridge Bicycle Skills Park (SRBSP) Sculpture – Proposal is to create a sculpture within the park. Proposed budget: \$200,000
Presentation proposal by Michael Shannon, Richard McCreedy, Tara Carrell, and Mike Tate.

- b. Juvenile Justice Service Mural in District B – Proposal is to create a mural on the external and if budget allows internal, of building. Artist would be compensated per square foot. Proposed budget: \$50,000.

Presentation proposal by Danilo Chavarria and Tara Carrell.

- c. Zap 16 in District B,D,& F – Proposal to paint only large Public Works utility boxes on Lamb. Artist would be compensated per square foot. Proposed budget is \$8,400.
- d. Zap 17 in District C, & F - Proposal to paint only large Public Works utility boxes on Desert Inn. Artist would be compensated per square foot. Proposed budget is \$8,400.
- e. Zap 18 in District A – Proposed utility box painting in Searchlight. Artist would be compensated per square foot. Proposed budget \$24,000

Presentation proposal by Kyle Myer and Mark Moskowitz.

Clark County Woman’s History Project in all Districts - Proposal is to hire a historian and graphic artist to build a website, and marketing imagery. Up to 10% of the funding may be used to fund a Woman’s History Exhibit at the Rotunda Gallery in March of 2025. Proposed budget: \$50,000.

Presentation proposal by Amber Colbert.

(See attachments.)

- 6. Arts and Economic Prosperity 6 (AEP6) recap and discussion (*not an action item*).
AEP6 recap and summary by Mickey Sprott. A full detailed report can be found on the [Clark County Public Arts website](#).
- 7. Report by staff regarding monthly summary of activities (*not an action item*).
(See attachments.)
- 8. Identify emerging issues by the Committee at future meetings (*not an action item*).
Discussion to advocate a percentage of construction or renovation budgets to go into public art aspect of the project.
- 9. Comments by the General Public.
No public comment.
- 10. Next Meeting Date: **BUDGET MEETING Tuesday, April 09, 2024.**
- 11. Adjournment.
Meeting adjourned at 5:36 PM.

5. Budget Presentations (*not an action item*).

- a. Southwest Ridge Bicycle Skills Park (SRBSP) Sculpture – Proposal is to create a sculpture within the park. Proposed budget: \$200,000
- b. Juvenile Justice Service Mural in District B – Proposal is to create a mural on the external and if budget allows internal, of building. Artist would be compensated per square foot. Proposed budget: \$50,000.
- c. Zap 16 in District B,D,& F – Proposal to paint only large Public Works utility boxes on Lamb. Artist would be compensated per square foot. Proposed budget is \$8,400.
- d. Zap 17 in District C, & F - Proposal to paint only large Public Works utility boxes on Desert Inn. Artist would be compensated per square foot. Proposed budget is \$8,400.
- e. Zap 18 in District A – Proposed utility box painting in Searchlight. Artist would be compensated per square foot. Proposed budget \$24,000
- f. Clark County Woman’s History Project in all Districts - Proposal is to hire a historian and graphic artist to build a website, and marketing imagery. Up to 10% of the funding may be used to fund a Woman’s History Exhibit at the Rotunda Gallery in March of 2025. Proposed budget: \$50,000.

Southwest Ridge Conceptual Tracks

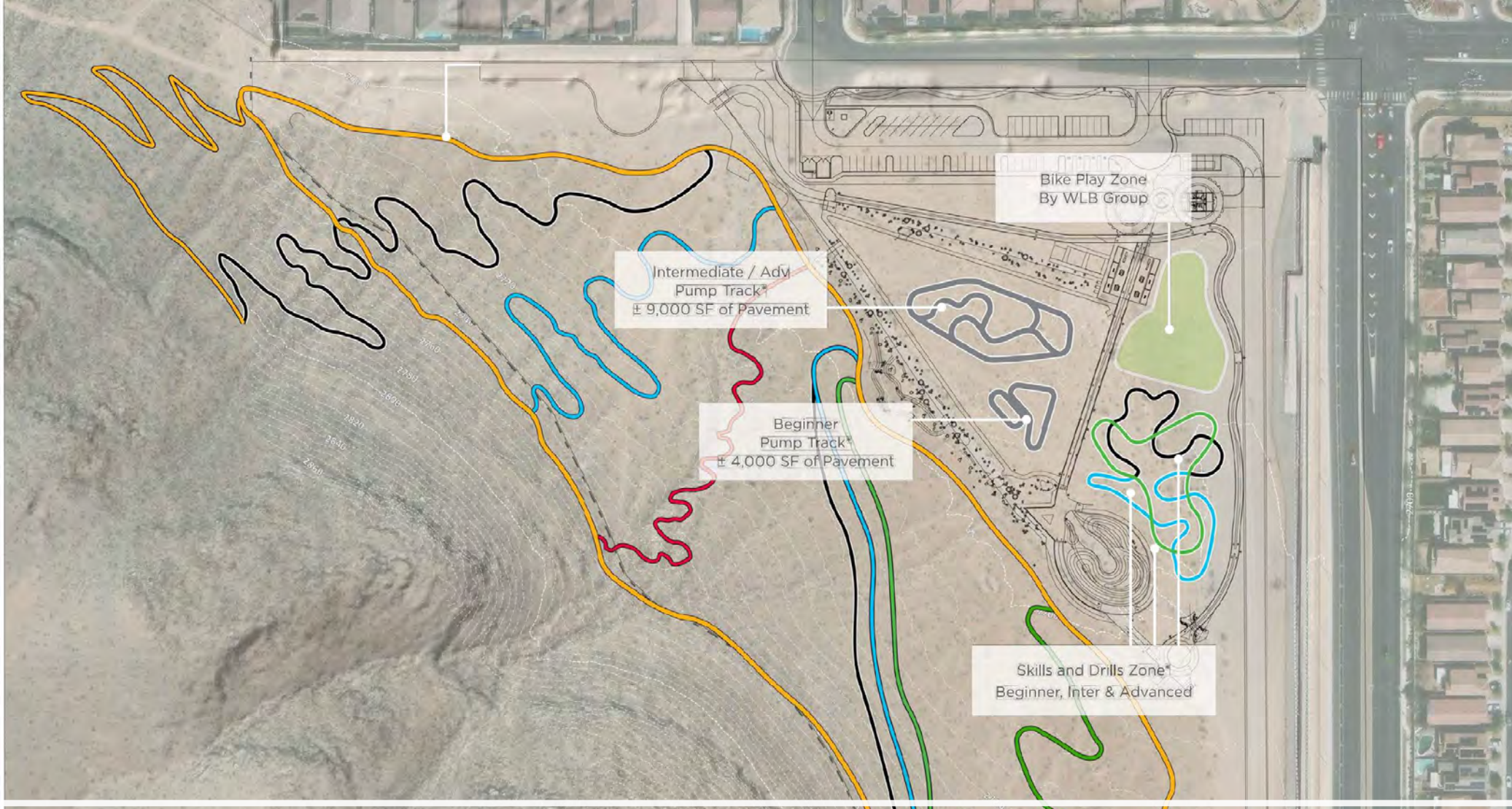

Southwest Ridge Bicycle Skills Park

*Pump Track and Skills Zone layouts are conceptual, for illustrative purposes. Actual layouts TBD in next round of creative development.

In Design

- Various skills bike park
- With flow track, and technical biking.
- It will feature a beginner pump course and various skills and drill opportunities.
- Down hill trails for beginner, intermediate and advance riders.

Tot Balance Bike Track + Skills Area -- Concept Sketch

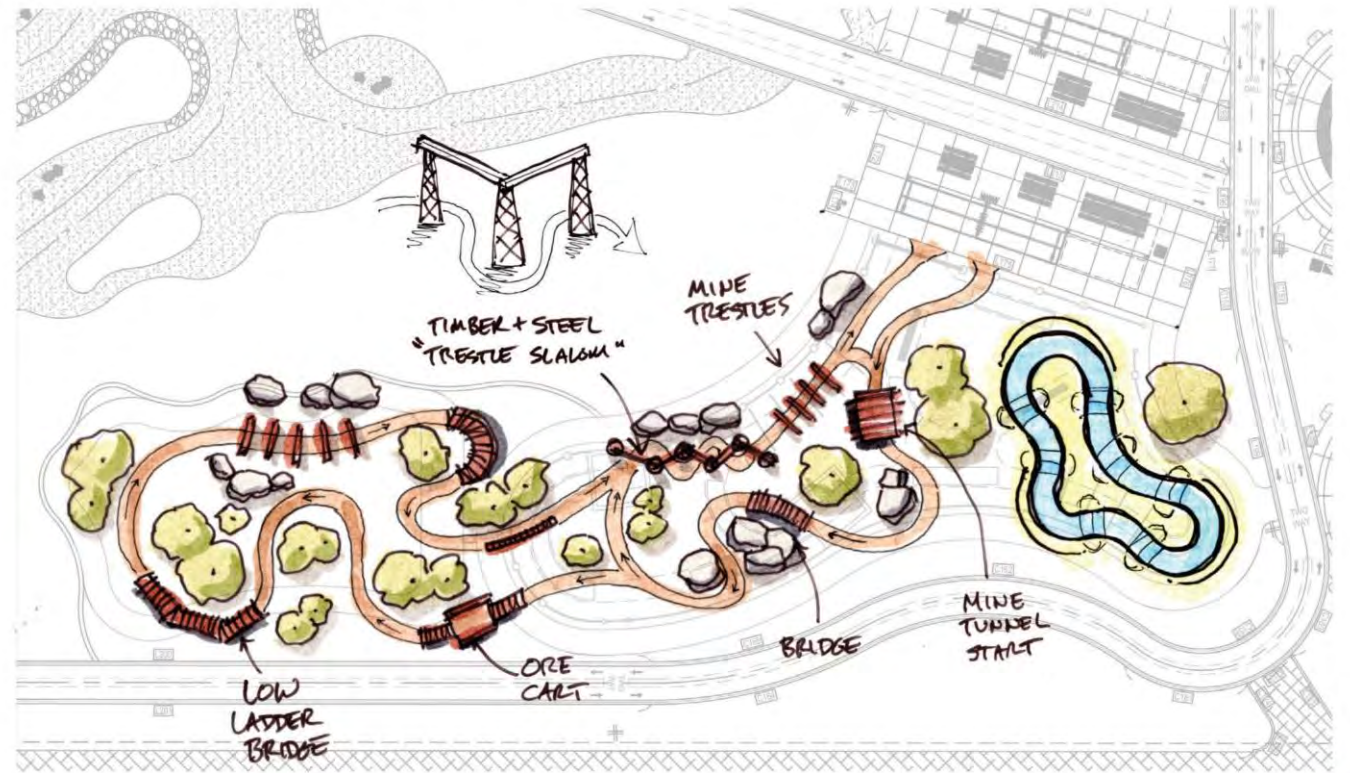

Demographics

- 44,101 people live in 89178
- 15,173 households in 89178 Zip Code
- Forbuss Elementary has 594 students enrolled.



Population by Race
Zip Code: 89178

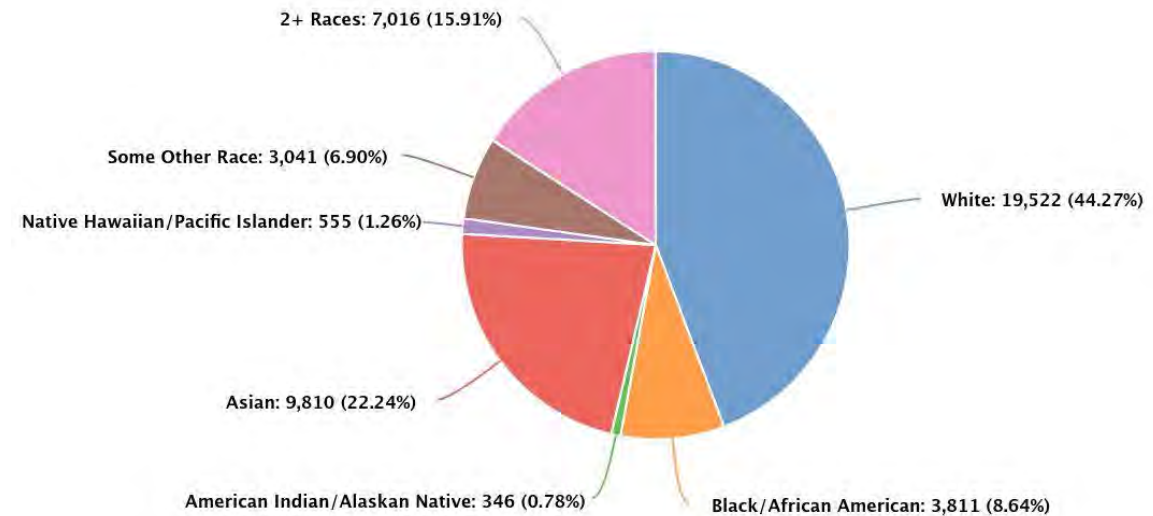

Claritas, 2023. www.healthysouthernnevada.org



Bike Park Community

The park will host a diverse skill levels for all ages.

Concrete work will be limited so much of the site can remain natural.

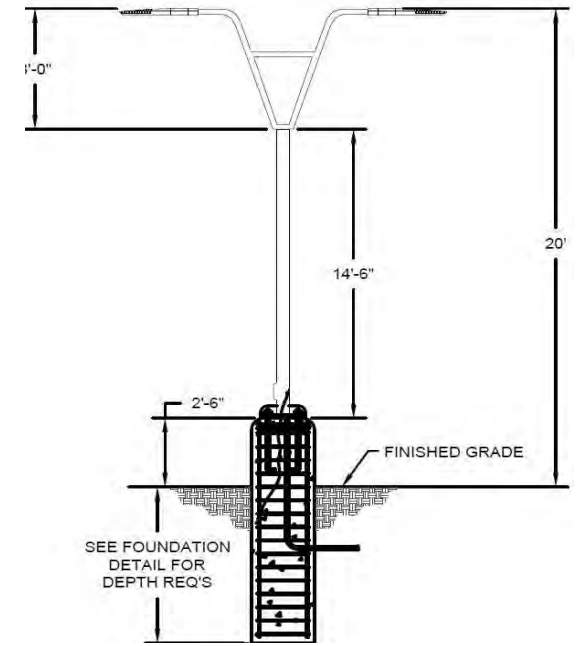
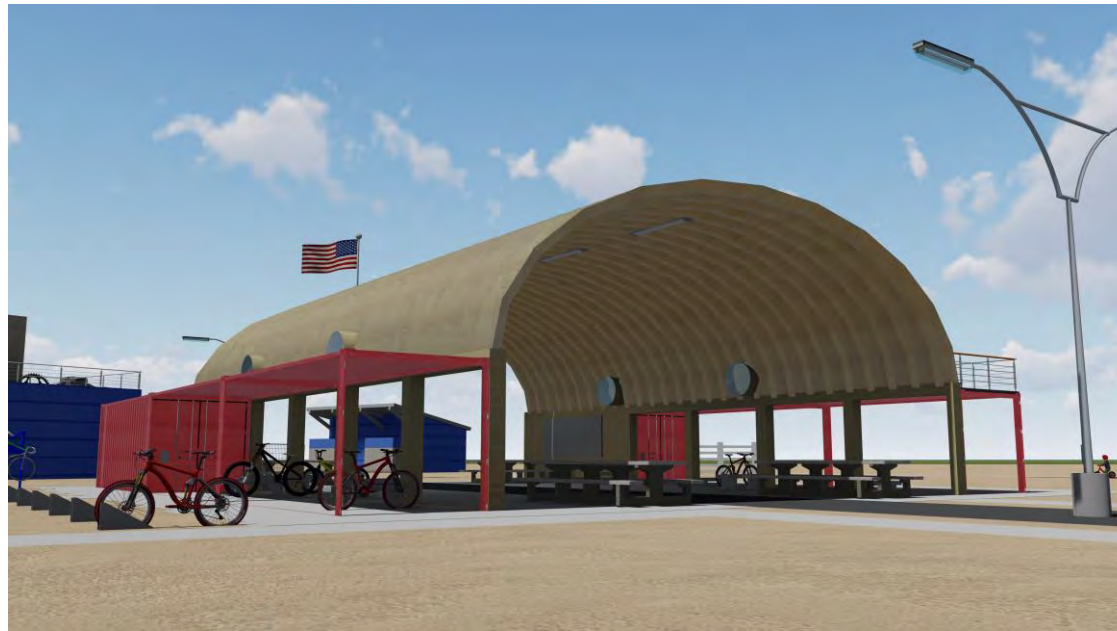
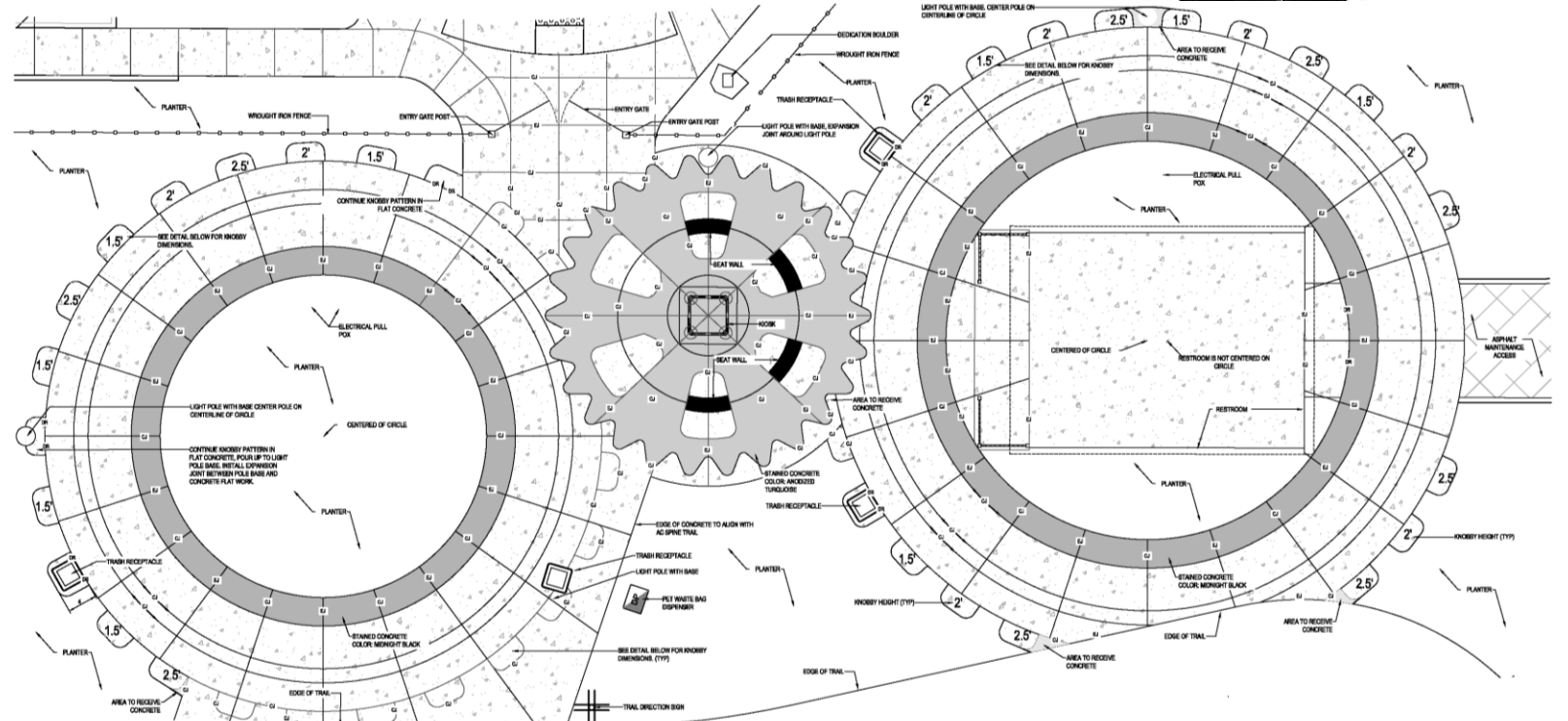

Artistic Features
Have been added
into the design to
enhance the
park.

Southwest Ridge Bicycle Skills Park (SRBSP) Sculpture

Proposal is to create a sculpture within the park.
Proposed budget: \$200,000



LEGEND

- PARK AMENITIES**
- (A) NEW HALF STREET IMPROVEMENTS WITH CURB-SAC
 - (B) PARKING LOT 50 SPACES AND TRAILER PARKING SPACES
 - (C) PARKING LOT DRAINAGE OUTLET AND BMP
 - (D) PUMP ENCLOSURE WITH PARKING LOT ACCESS GATES
 - (E) TRASH ENCLOSURE
 - (F) STREETSCAPE WITH A 5' MEANDERING SIDEWALK
 - (G) DECORATIVE ENTRY DROP-OFF CURB-SAC WITH BWS BRACKS, LOOKING GATES, AND ENTRY MONUMENT
 - (H) 18 FUTURE PARKING SPACES
 - (I) MAIN MAINTENANCE ACCESS POINT
 - (J) FACILITY MAINTENANCE ACCESS POINT
 - (K) EMERGENCY ACCESS ASPHALT ROAD
 - (L) POST AND CABLE FENCE
 - (M) ADMIN BUILDING AND STORAGE FACILITY
 - (N) KIOSK WITH MAPS, RULES, AND SEATING
 - (O) RESTROOM
 - (P) FUTURE TRACK OR EVENT STAGING AREA
 - (Q) LARGE GROUP SHELTER AND MAINTENANCE COVER EQUIPMENT STORAGE
 - (R) SMALL GROUP SHADE SHELTERS 'FUTURE OR POSSIBLE ADD ALTERNATES'
 - (S) FLAGPOLE WITH FLAG AND UP LIGHTS
 - (T) BIKE WASH STATION WITH PRESSURIZED WATER
 - (U) THE MAIN PROMENADE 'THE APPROACH'
 - (V) COPPER CANYON - CALICHE GARDEN APPOINTMENT WITH 11 ELEVATED DECOMPOSED GRANITE TRAIL
 - (W) THE DESERT GROOVY GROVE SHAVED GRAY AREA
 - (X) THE WASH OVERLOOK WITH BIRK REPAIR AND AIR STATION
 - (Y) THE BIG WASH - GREEN BELT TRAIL BOULDER OBSTACLE COURSE WITH TERRACED SEATING AREA
 - (Z) THE LITTLE WASH - GREEN BELT TRAIL BOULDER OBSTACLE COURSE

TRACK DESCRIPTIONS

- (1) THE POSSIBLE PUMP TOT LOOP & PUMP TRACK AREA (1 TOT LOOP AND 1 BEGINNER PUMP TRACK)
 - (2) THE ROCK BEGINNER PUMP TRACK (1 PUMP TRACK)
 - (3) THE BOULDER INTERMEDIATE/ADVANCED PUMP TRACK AREA (1 PUMP TRACK)
 - (4) FLOW TRACK 'EXTREME' OPTION
 - (5) FLOW TRACK 'MODERATE' OPTION
 - (6) FLOW TRACK 'CONSERVATIVE' OPTION
 - (7) D.G. WALK OFF, WALK UP TRAIL
 - (8) THE LV STRIP - DROP ZONE AND BEGINNER GRAVITY SKILLS AREA (3 DOWN HILL RUNS)
 - (9) JOSHUA'S RUNS - ADVANCED GRAVITY JUMP TRAILS AREA (3 DOWN HILL RUNS)
 - (10) COPPER RIDGE BYPASS - ADVANCED PUMP TRACKS AND SKILLS AREA (BEGINNER GRAVITY JUMP TRAILS (1) GRAVITY TRACK & 2 DOWN HILL RUNS)
- POSSIBLE DROP-IN LOCATION SYMBOL

Juvenile Justice Services

- **The Department of Juvenile Justice Services** is a comprehensive public service agency that performs more than the traditional Juvenile Court functions of probation and detention. The department provides intervention services, guidance and control for youth ages 18 and under who are involved in delinquency and truancy.

Vision

To inspire a successful future for youth, families, and our community.

Mission

To improve and strengthen youth and families through positive relationships and targeted programming.



Department of Juvenile Justice Services

- The Department of Juvenile Justice Services (DJJS) is a comprehensive public agency that performs more than the traditional Juvenile Court functions of probation and detention. For delinquent youth who are 18 and under, the department provides services for intervention, guidance, detainment, treatment, counseling and accountability. The department consists of four divisions providing direct services to you.
- [Health Services](#)
- [Juvenile Detention](#)
- [Probation](#)
- [Spring Mountain Youth Camp](#)

JJS Building at Sunrise Park

- Container building
- 4500 square feet Building
- Building has not been designed as of yet.



RETAIL
Container Park – Las Vegas, NV



COMMERCIAL
OC Fire Authority 67 – Mission Viejo, CA



COMMERCIAL
Allegiant Stadium – Las Vegas, NV



RETAIL
Planet13 – Las Vegas, NV



MULTI-STORY HOSPITALITY
Hotel Topock 66 – Topock, AZ



OFFICE
U.S. and expanding worldwide



MULTI-FAMILY AFFORDABLE HOUSING
Northern CA



SCHOOLS/CLASSROOMS
Western U.S. and expanding



INDUSTRIAL
Avisight – Remote Locations

JJS – Mural at Sunrise Park

Proposal is to create a mural on the external and if budget allows internal, of building. Artist would be compensated per square foot. Proposed budget: \$50,000.



ZAP FY25

Zap 16 in District B,D,& F – Proposal to paint only large Public Works utility boxes on Lamb. Artist would be compensated per square foot. Proposed budget is \$8,400.

Zap 17 in District C, & F - Proposal to paint only large Public Works utility boxes on Desert Inn. Artist would be compensated per square foot. Proposed budget is \$8,400.

Zap 18 in District A – Proposed utility box painting in Searchlight. Artist would be compensated per square foot. Proposed budget \$24,000

\$14.55 per square foot



Searchlight Community

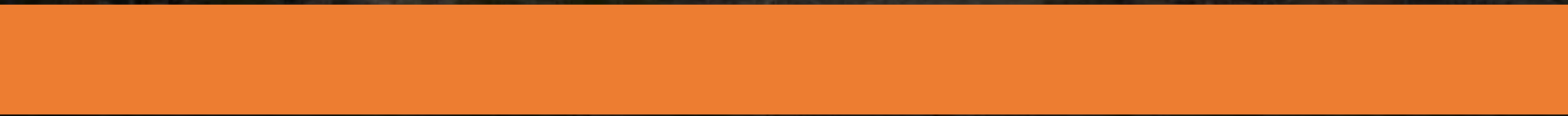

ZAP Searchlight



District A
Commissioner: Michael Naft

1. Reid Elementary School
2. Reid Elementary School
3. LVMPD
4. Cottonwood Cove Boat Storage
5. Cottonwood Cove Boat Storage
6. Terrible's Roadhouse
7. Joshua Tree Highway
8. Rebel Gas Station
9. McDonald's
10. Terrible's Casino
11. Terrible's Casino
12. BV Motel
13. Hobson
14. Cal-Nev-Ari Market & RV Park



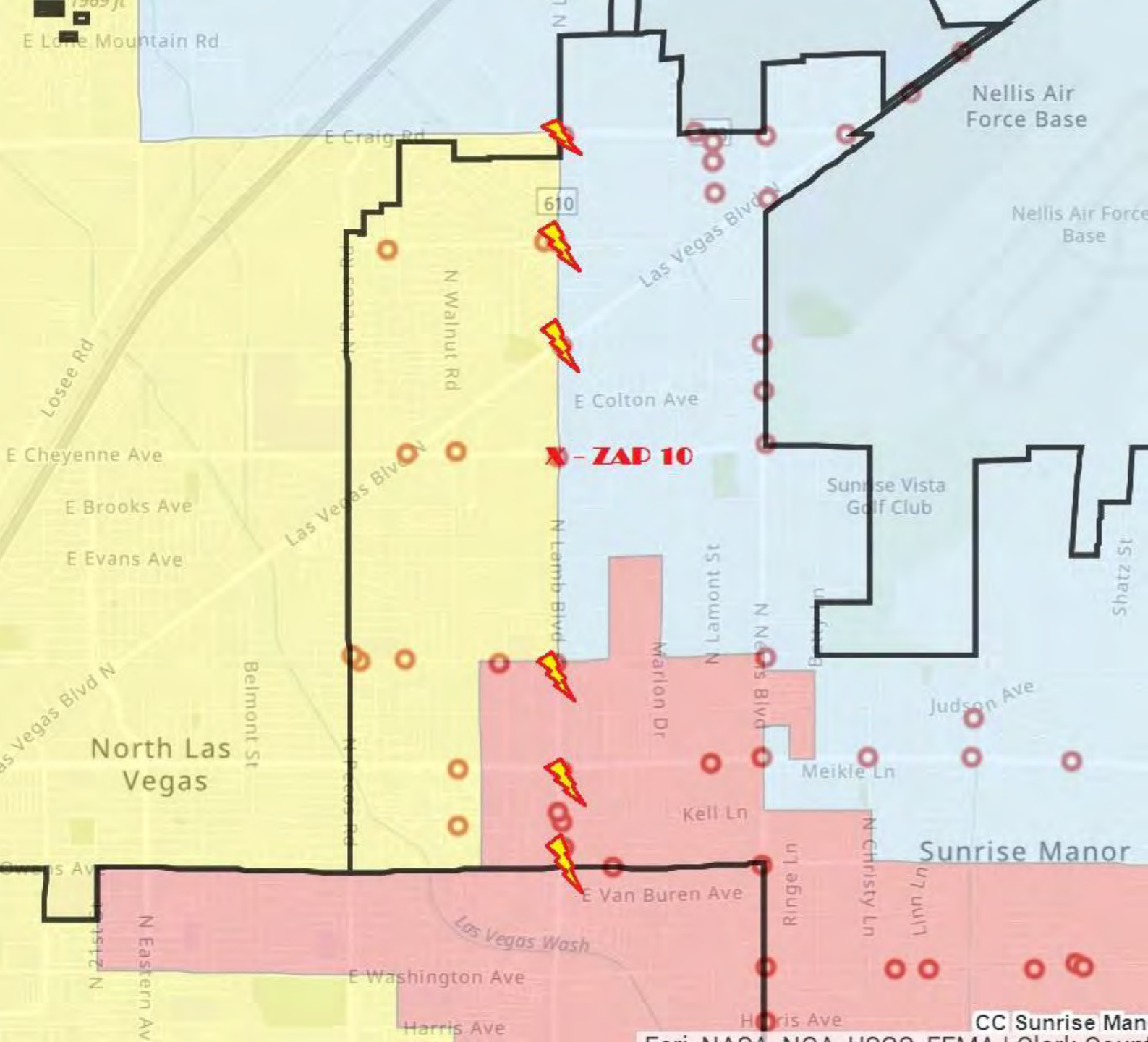

ZAP 16 - Lamb

District B, D, and E

Commissioners: Marilyn Kirkpatrick, William McCurdy II, and Tick Segerblom

Total Boxes = 6

1. Craig / Lamb
2. Alexander / Lamb
3. Las Vegas Blvd / Lamb
4. Carey / Lamb
5. Lake Mead / Lamb
6. Owens / Lamb

Budget

$\$1200 \times 6 \text{ boxes} = \$7200 + \$1200 \text{ (contingency)} = \8400

ZAP 17 – Desert Inn



District C & F

Commissioners:

Ross Miller

Total Boxes = 6

1. Hualapai / Desert Inn
2. Grand Canyon / Desert Inn
3. Fort Apache / Desert Inn
4. Crystal Water / Desert Inn
5. Cimarron / Desert Inn
6. Hualapai / Count Diero

Budget

$\$1200 \times 6 \text{ boxes} = \$7200 +$

$\$1200 \text{ (contingency)} = \8400

Clark County Woman's History Public Art Project

WOMEN'S HISTORY

- **Women's history** is the study of the role that women have played in history and the methods required to do so. It includes the study of the history of the growth of woman's rights throughout recorded history, personal achievements over a period of time, the examination of individual and groups of women of historical significance, and the effect that historical events have had on women. Inherent in the study of women's history is the belief that more traditional recordings of history have minimized or ignored the contributions of women to different fields and the effect that historical events had on women as a whole; in this respect, women's history is often a form of historical revisionism, seeking to challenge or expand the traditional historical consensus.





Anna Bailey, Ruby
Duncan, Thalia Dondero

- <https://www.reviewjournal.com/local/local-nevada/7-women-who-changed-nevada-history-2737625/>
- <https://www.youtube.com/watch?v=xP5ydv451Pw>

Clark County Woman's History Public Art Project

- Requested by Marilyn Kirkpatrick
- Part 1 would be to focus on hiring a historian and graphic artist to collect and provide a Clark County specific list of Woman who played a vital roll in our Clark County history.
- Website would live on Clark County webpage and have links to additional groups and efforts of woman's history.
- From this project would give the committee a clear direction on funding additional permanent murals and sculptures that highlight these historical women.



Clark County Woman's History Project

Proposal is to hire a historian and graphic artist to build a website, and marketing imagery. Up to 10% of the funding may be used to fund a Woman's History Exhibit at the Rotunda Gallery in March of 2025. Proposed budget: \$50,000.



7. Report by staff regarding monthly summaries of activities (*not an action item*).

FULL SCOPE WORKSHOP

CLARK COUNTY PARKS & RECREATION PRESENTS:

FULL SCOPE

workshop PUBLIC ARTS

Jessica Scheitler

Financial Groove, LLC

Date
Tuesday, March 19, 2024

Time
10:00 am PT

Link to Join
<https://tinyurl.com/FullScopeMarch2024>

Tax Preparation for Artists

• Attendees will learn how to prepare and file taxes as an artist.  togetherforbetter



Free Book Alert!

Join in to find out how to receive a copy of "I'll Make Me A World" by Thomas Lawson"

For more info, please visit:



DATE: Tuesday, March 19, 2024

TIME: 10:00 AM PT

SPEAKER: Jessica Scheitler, Financial Groove LLC

Full Scope Workshop for March will be a presentation by Tax Preparer and Owner of Financial Groove, Jessica Scheitler. Jessica will cover topics on how to prepare and file taxes as an artist.

The presentation will be followed by a question-and-answer segment where attendees will have a chance to ask Jessica questions about the topics discussed. This workshop will be recorded and will be posted on the Clark County's website and social media.

During announcements, learn how to receive a copy of the book I'll Make Me A World by Thomas Lawson. This book is part of the Some Place Chronicles, a creative placemaking project set in four unincorporated communities of Los Angeles County.

Website: <http://tinyurl.com/FullScopeMarch2024>

SOLO SERIES: “SELF REPARATIONS” BY ANTHONY JOHNSON

- **Exhibiting:** February 14, 2024 – April 12th, 2024
Reception: Friday March 8, 6:00 PM – 8:00 PM

Workshop: Tuesday March 19, 3:30 PM – 5:30 PM
Sign-up at: <http://tinyurl.com/artwithanthony>

- The exhibition depicts black and white work in oil paint and pencil. Johnson chooses to highlight subjects like Malcolm X to shine light on positive influences and messages that come from the people who were born and brought up in America’s struggle to provide equality to all people. He uses detail to aide the viewer and grasp their attention immediately.
- There will be a reception that is open to the public on Friday March 8th, 2024 from 6pm-8pm. Light refreshments will be provided. The reception will be accompanied by guitar and vocals by Win Frederick. Win Frederick is a writer and song-poet from Las Vegas, NV.
- Anthony Johnson will be leading an all-ages still-life drawing workshop on Tuesday March 19th from 3:30pm-5:30pm in the art room at Pearson Community Center.



CLARK COUNTY OFFICE OF PUBLIC ARTS & WINCHESTER GALLERY PRESENTS

DIGITAL LOVE: ART & TECH

JURIED BY
MICHAEL FONG

FEBRUARY 13, 2024 - MARCH 21, 2024

WINCHESTER-DONDERO CULTURAL CENTER
3138 MCLEOD DRIVE, LAS VEGAS, NV 89121

RECEPTION
THURSDAY, MARCH 21 2024 5:30PM - 7:30PM

GALLERY HOURS
TUESDAY - SATURDAY 9:00AM - 8:00PM
SUNDAY-MONDAY CLOSED

EXHIBITION: *DIGITAL LOVE: ART + TECH* AT
WINCHESTER-DONDERO GALLERY

JURIED BY MICHAEL FONG

Exhibiting: February 13, 2024 – March 21, 2024

Reception: Thursday, March 21, 2024, from 5:30pm – 7:30pm

Digital Love: Art + Tech examines how technology influences our lives through the lens of the artist. The artists in this exhibition submitted work that focused on our interactions with technologies and the abstract emotion of love when compared to or with the use of machines. The tech used for this show varies in scope and adds to the documentation of our use of tools to help us achieve creative works. The exhibition will be on view from February 13, 2024, to March 21, 2024 with a reception happening the last day of the exhibition on Thursday, March 21, 2024.

Artists in this exhibit include: Dyron Boyd, Michael Cassera, Juan Cuevas, Mayra Duran, Jaiden Gaddy, Antonio Gomez, Rebecca Goodman, Brittney Hart, Terrence Jenkins, Narz, Nykol, Zoe Mekelle, Alexander Scarrone, Linda Shaffer, Lane Sheehy, Lydia Silic, Pawel Tomasik

This show is juried by Michael Fong, an Assistant Professor in the Graphic Design and Media Program at the University of Nevada Las Vegas. He is recognized as an expert in design, art, and technology. Michael's creative work utilizes multiple disciplines to explore the mysteries that humans have created for themselves. Michael's expertise lends him the ability to be part of many projects across disciplines. In his most accomplished work, Michael was invited to collaborate in a nationally recognized festival at The Momentary, a contemporary art space of Crystal Bridges Museum of American Art. From digital fabrication consultation, book covers, art technology experiences, to branding identity, Michael is a firm supporter of the arts and technology development in Las Vegas.

OPEN CALL: AT THE COUNTY FAIR AT ROTUNDA GALLERY JURIED BY JESUS SOLIS-LEON

Application Deadline: Sunday, March 24, 2024 @ 11:59 PM

Reception Date: TBD

Application Link: <http://tinyurl.com/atthecountyfair>

We are pleased to announce a call for art for our newest exhibition, *At the County Fair*, at Rotunda Gallery inside the Clark County Government Center.

The Clark County Fair had its beginning back in 1965. Known as the Moapa Valley Fair, it was held at the Overton Community Center. Compared to the present-day fair, this first fair was small but, it had all the flavor and elements of a good old county fair. From this simple beginning, the Moapa Valley Fair became an annual event. Each year new attractions were added, such as a carnival midway, junior livestock show, and a rodeo. Now known as the Clark County Fair & Rodeo, the event has grown to receiving 80,000 visitors every spring. We encourage artists to submit work that digs into crafts such as quilting, sewing, pottery, beading, and leatherworking. Artists should also look at the aesthetics of the fair for inspiration; Ferris wheels, rodeos, kettle corn, and barbershop quartets are all common county fair visuals. One of our partners in this event is 4-H Youth Development where they teach children about leadership, citizenship, and life skills so anything educational and informational will also help make an impact for this open call. This exhibition not only honors the legacy and culture of our own county fair, but that of county fairs in general! Remember reading or watching Charlotte's Web? That's what we're looking for! "...this lovely world, these precious days..." all when we meet *At the County Fair*.





Clockwise from top left: Brent Holmes at Whitney, Shereen Sun at Hollywood, Hue at Wetlands

YOUTH ARTS EDUCATION: TEMPORARY PUBLIC ART

Public Workshops:

- Total of ten workshops since January.
- Eight artists at 16 different recreation and cultural centers
- Attendance averages 19 children
- Total attendance of all workshops to date: 259
- Artists participating with afterschool programs, spring break camps, community events.
- All workshops will be completed by mid April.
- After public workshops, artists create installations to go at each center.

New additions:

- Program at Spirit Mountain Activity Center in Laughlin.
- Expanded promotional efforts to share workshops and promote to the general public and arts audiences.
- Press release to media for bring awareness to program
- Website updates and more presence for program
- May Exhibition at Winchester – opportunity for artists to create and exhibit work.

YOUTH ARTS EDUCATION: TEMPORARY PUBLIC ART

Public Art Installations

- So far three artists have installed their work:
 - Emily Relf at Cambridge through March 29
 - Joan Paye Helen Meyer through April 1
 - Hue at Wetlands through mid-April

Upcoming exhibits, dates pending:

- Emily Robinson at Paradise and Desert Breeze
- Shereen Sun at Hollywood and Walnut
- Emily Relf at Clark County Museum, April-May
- Brent Holmes at Whitney and Moapa Valley
- Ross Takahashi at Pearson and Searchlight
- Hue at Winchester Dondero April-May
- Group Exhibition at Winchester Dondero Gallery May



Above: Emily Relf at Cambridge
Left: Joan Paye at Helen Meyer

YOUTH ARTS EDUCATION: TEMPORARY PUBLIC ART

Group Exhibition

Winchester Dondero Cultural Center

Exhibition Runs: May 1-30

Participating Artists

- Karen Castaneda
- Hue Chen
- Brent Holmes
- Joan Paye
- Emily Relf
- Emily Robinson (Emenro)
- Shereen Sun
- Ross Takahashi

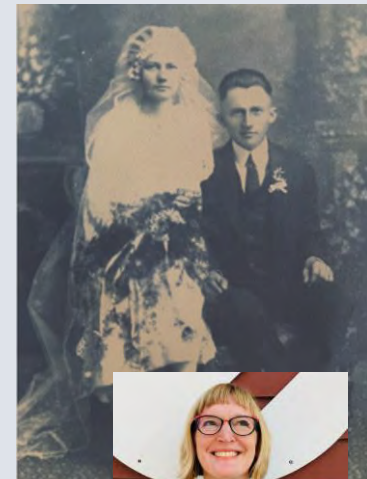
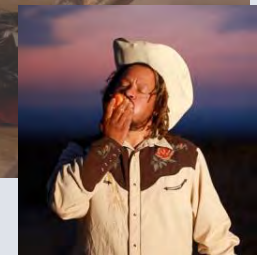
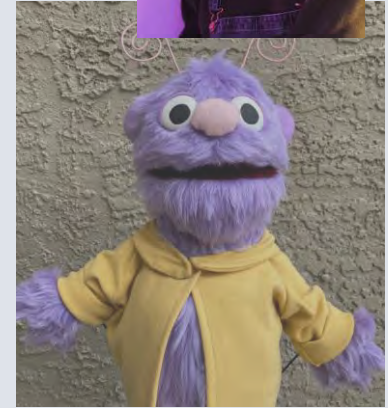
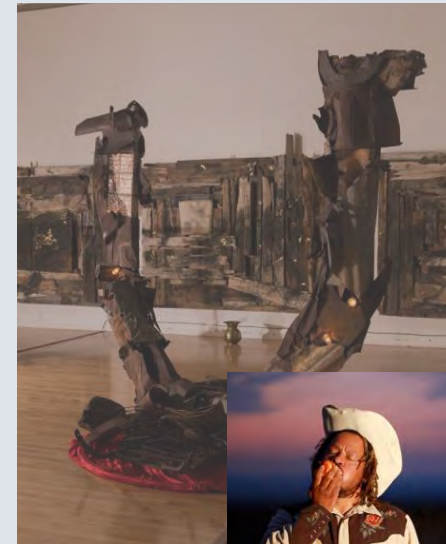
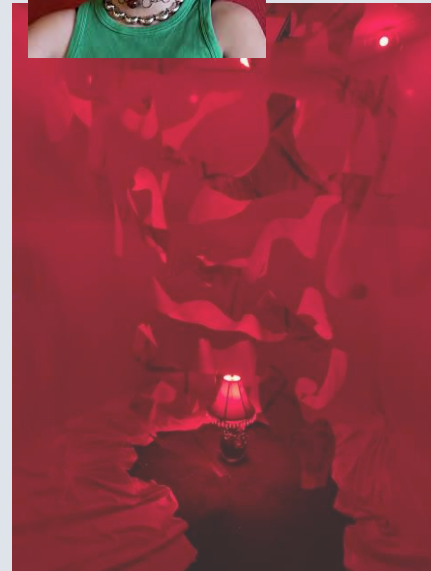
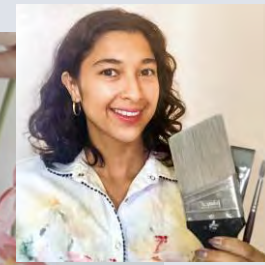
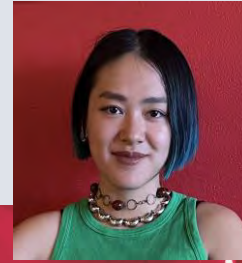

SOCIAL MEDIA INSIGHTS



We've reached **+14%** more accounts compared to Jan 6 - Feb 4

Accounts reached: **1,895 / +14%**

Accounts engaged: **486 / +17.6%**

Total followers: **2,786 / +1.8%**

Top Post Reach: **1,236 accounts reached (1,073 followers/163 non-followers)**



Accounts Reached: **1,666 / -11% past 28 days**

Reels: **110 / +28%**

Audience: **27% followers / 73% non-followers**

Engagement: **290 / +12%**

Published **42%** more content

Both platforms

Art Calls / Fullscope Workshop / Calls to action generate the highest engagement



WILD AT HEART

JOIN OUR E-MAIL LIST TO STAY UP-TO-DATE
ON OUR UPCOMING EVENTS



tinyurl.com/ccpublicarts

EXHIBITIONS

DIGITAL LOVE: ART & TECH

Juried by Michael Fong

February 13, 2024 - March 21, 2024

RECEPTION

Thursday, March 21 • 5:30pm - 7:30pm

Winchester-Dondero Cultural Center

3130 McLeod Drive, Las Vegas, NV 89121

SOLO SERIES:

SELF REPARATIONS

by Anthony Johnson

February 14, 2024 - April 12, 2024

RECEPTION

Friday, March 8 • 6pm - 8pm

WORKSHOP

Tuesday, March 19 • 3:30pm - 5:30pm

Pearson Community Center

1625 W. Carey Avenue, Las Vegas, NV 89032

ART CALLS

★ AT THE ★ COUNTY FAIR

Juried by Jesus-Solis Leon
of 4-H Youth Development

APPLICATION DEADLINE

Sunday, March 24, 2024 @ 11:59pm

TO APPLY, PLEASE VISIT

<http://tinyurl.com/countyfairartcall>

EMPOWERMENT ART Paradise Recreation Center

SUBMISSION DEADLINE

Thursday, March 28, 2024 @
11:59pm

APPLICATION WORKSHOP WILL BE HELD

Thursday, March 14, 2024 • 10am

TO APPLY, PLEASE VISIT

<http://tinyurl.com/ParadiseEACallForArtist>

EVENTS

FULL SCOPE WORKSHOP

Jessica Scheitler of Financial Groove, LLC

TAX PREPARATION FOR ARTISTS

Tuesday, March 19, 2024
10am PT

TO JOIN, FOLLOW LINK:

<https://tinyurl.com/fullscopemarch2024>

WETLANDS ART DAY

Saturday, March 23
10am - 2pm

Wetlands Park Nature Center

7050 Wetlands Park Lane, Las Vegas, NV 89122



togetherforbetter

Jaguar by Miguel Rodriguez

ADVERTISING

Double Scoop and Black Image

- Join e-mail list for upcoming events and hiring Nevada artist to create public art
- Exhibitions/ Events / Art Calls Upcoming Calendar

WILD AT HEART

HIRING NEVADA ARTIST TO CREATE PUBLIC ART

FOR MORE INFORMATION, JOIN OUR EMAIL LIST
[TINYURL.COM/CCPUBLICARTS](https://tinyurl.com/ccpublicarts)



togetherforbetter

JAGUAR BY MIGUEL RODRIGUEZ

WILD AT HEART. CLARK COUNTY PUBLIC ARTS OFFICE
HIRING LOCAL ARTISTS TO CREATE PUBLIC ART!

Miguel Rodriguez 'Jaguar'



JOIN THE FAMILY AT CCPUBLICART@CLARKCOUNTYNV.GOV AND [@ccpublicarts](https://www.instagram.com/ccpublicarts) 

Need help with your applications for Public Art?

The Clark County Public Arts Office Staff are here to help you succeed by helping you create an application packet that is professional and informative. Email CCPublicArt@ClarkCountyNV.gov to schedule your one on one 30-minute session.



SILVERADO RANCH COMMUNITY CENTER SCULPTURE: DISTRICT A

Budget: \$250,000 *Estimated expense: \$179,396.52*
Scope: To create a sculpture at the community center.

Projected Completion Date: March 2024

Budget approved FY22 on June 1, 2021 agenda item #14, request from the design team.

Talley Fisher is the contracted artist.

<https://talleyfisher.com/>

- 2/13/2024: Rigging Technologies PO is being worked on. A FD6 memo from P&R was needed. Artwork to be installed March 18-29.



WEST FLAMINGO SENIOR CENTER MOSAIC MURAL PROJECT: DISTRICT A

Budget: \$10,000

\$13,000 sent to RPM

Scope: A ceramic mosaic mural at the entrance of the Senior Center

- 11/01/2023: Call ended
- 01/09/2024: Three (3) Finalists have been selected and an interview meeting is being coordinated for next week or the following
- 2/13/2024: Sierra Slentz has been selected for the commission, the paperwork is ready for the artist and a plan for the community outreach will be coordinated with the West Flamingo Senior Center.
- Artist Sierra Slentz will be creating the mural on the column at WFSC.
- 3/6/24 PO has been generated for the project; the first payment will be issued in a week's time for the artist to start the first milestone.



FAMILY COURT HOUSE COURTYARD MURAL: DISTRICT D

- Budget: \$74,481
- Scope: To create mural(s) on walls.
- Budget approved for FY22 on June 1, 2021, agenda item #14

- 11/14/23: Jury meeting- the project had the first meeting with the Jury. The call is being written with the input from the jurors.
- 3/6/24 The call, first contract and second contract have been submitted. The call for artists will be going out.

CLARK COUNTY PARKS RECREATION'S
OFFICE OF PUBLIC ARTS PRESENTS

Pearson Pillar Mural Project

CALL FOR
EXPERIENCED ART
TEAM

\$56,000



PEARSON COMMUNITY CENTER PILLAR MURAL PROJECT: DISTRICT D

Budget: \$70,000

Scope: For pillars to be painted by a team of artists including hiring a professional videographer for

- 4/10/2023: Final draft created – under review by purchasing
- 9/6/2023: Call is almost complete.
- 11/14/2023: Call approved by Purchasing
- 1/9/2024 Mural call approved –
 - Call for Emerging Filmmaker to create a short documentary of mural process in progress.
 - Both film and mural call will go out at the same time.
- 3/7/2024 Making final edits for both calls – Both Calls out week of March 10.

VON TOBEL MODULAR BUILDING VINYL WRAP PART 1: DISTRICT D

Budget: \$70,000 *Estimated expense: \$24,590*

Scope: To create a vinyl mural on the exterior surface of the community center at Von Tobel Park. The artist(s) will work with children, then create a digital design that integrates ideas learned by the community. The printing and installation of the artwork will be managed by county staff.

- 9/6/2023: Dedication complete
- 11/13/2023 Olympus scheduled to remove vinyl inside building on Wednesday, November 15 at 8am.
- 1/9/2024 RPM to hire new company to prep wall for re-installation of vinyl
- 3/7/2024 Waiting for RPM to receive quote to prep wall
Possibility of hiring new vinyl company

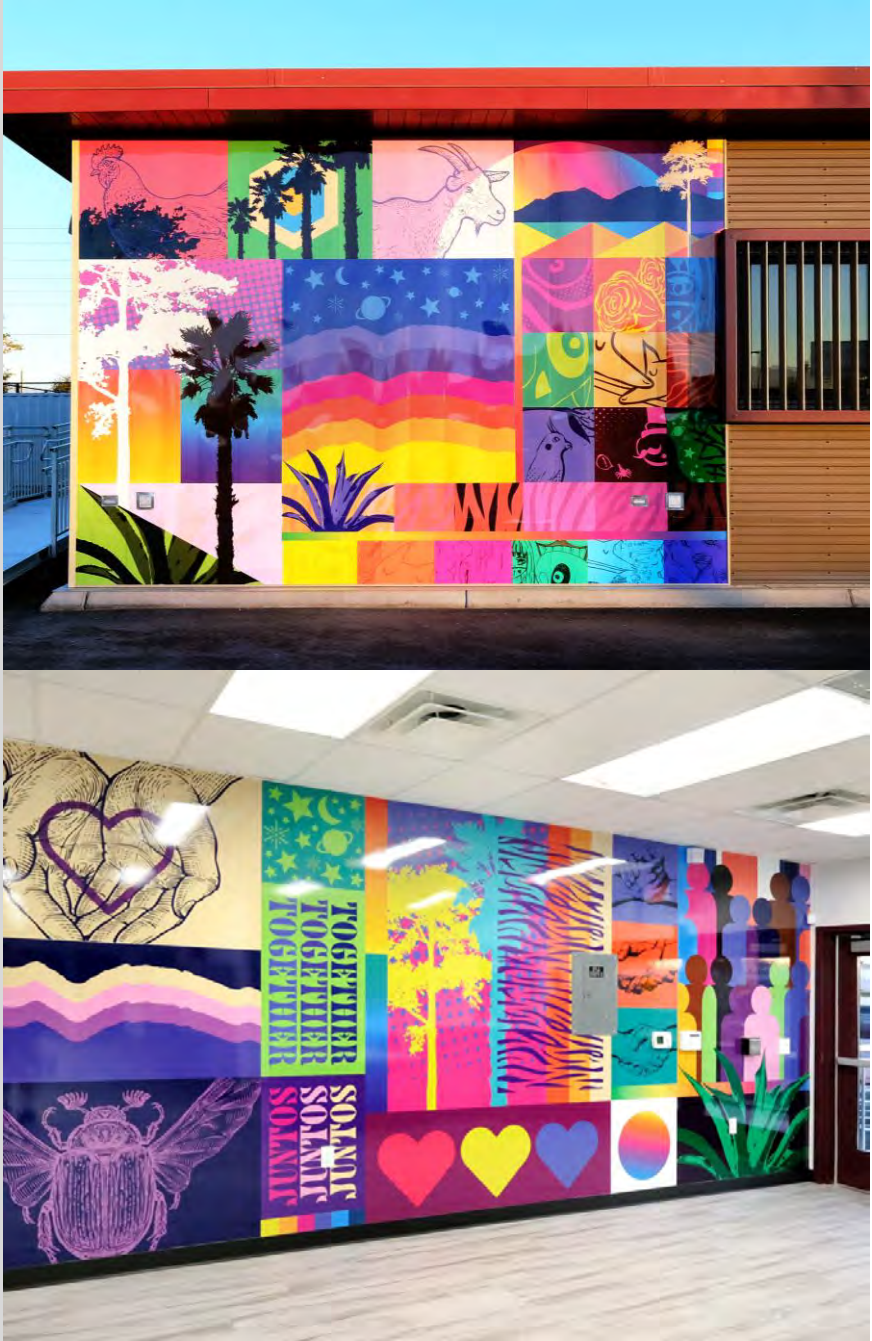

VON TOBEL PARK SCULPTURE PART 2

Budget:\$131,671 *Estimated expense: \$49,445.63*

Scope: Proposal is to create a sculpture within the park. The artist(s) will work with children from the area that will inform the artist the direction of the sculpture.

- Projected Completion Date: June 2024
- Awarded Artist: Domsy Glass
- 3/7/24 Possible install the week of April 15



AESS Welding Images



